

Flap wheels with aluminum oxide A grain are recommended for all materials.

Abrasive: Aluminum oxide A

PFERD specification number
FR A

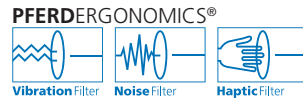

Unmounted flap wheels
Aluminum oxide A

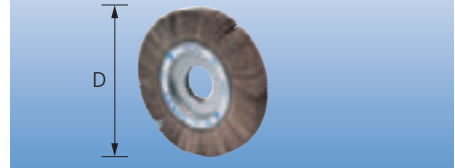

Diameter (D) x width [Inches]	Bore	Grit and EDP number						Recom. speed RPM	Max. RPM	
		40	60	80	120	180	240			
4 x 1	1	45530	45532	45533	45535	45536	-	5,500	9,500	2
4 x 2	1	-	45552	45553	45555	-	-	5,500	9,500	2
6 x 1	1	45600	45602	45603	45605	45607	-	3,500	6,300	2
6 x 1-1/2	1	45610	45612	45613	-	-	-	3,500	6,300	2
6 x 2	1	45620	45622	45623	45625	45626	45627	3,500	6,300	2
8 x 1	1-3/4	-	45642	45643	45645	-	-	2,600	4,700	2
8 x 2	1-3/4	-	45652	45653	45655	-	-	2,600	4,700	2

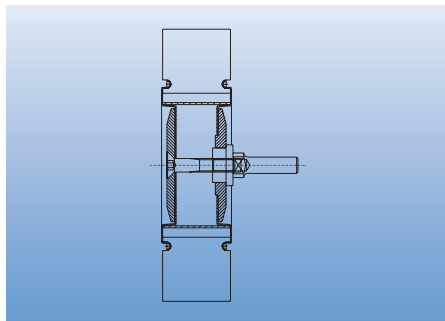

These arbor and flange combinations are intended specially for mounting PFERD flap wheels and POLINOX® wheels. The clamping flanges fit into the recess around the flap wheel's centre hole. This design provides optimum face-down grinding, even near edges and corners.

Contents

- 1 arbor 1/2" clamping dia.
- 2 flanges
- suitable clamping screws (for various flap wheel widths)

PFERD specification number
FR/VR

Arbors for flap wheels



Shank diameter [Inches]	Clamping width [Inches]	Fits flap wheel I.D. [Inches]	For wheel diameter [Inches]	EDP number	
1/2	1-2	1	4 - 6	45714	1
1/2	1-2	1-3/4	8 - 10	45715	1

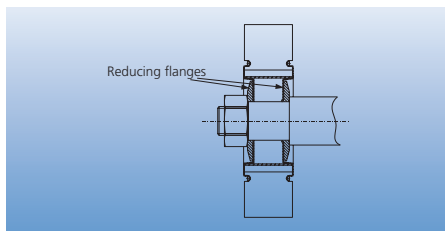

These reducing flanges can be used to mount PFERD flap wheels and POLINOX® wheels on a stationary machine (bench grinder).

Ordering note

- 1 pair per box

PFERD specification number
RF/FR

Flap wheel reducer flanges



Fits flap wheel I.D. [Inches]	Bore [Inches]	For wheel diameter [Inches]	EDP number	
1	1/2	4-6	45720	1
1	5/8	4-6	45721	1
1	3/4	4-6	45722	1
1-3/4	1/2	8-10	45725	1
1-3/4	5/8	8-10	45726	1
1-3/4	3/4	8-10	45727	1
1-3/4	1	8-10	45728	1